

# Tork Foam Soap Dispenser

S4

Image  
Design

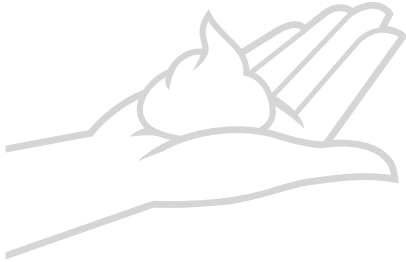
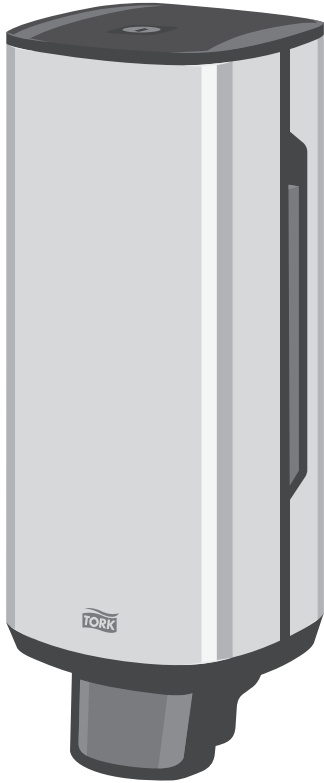

# Tork Foam Soap Dispenser

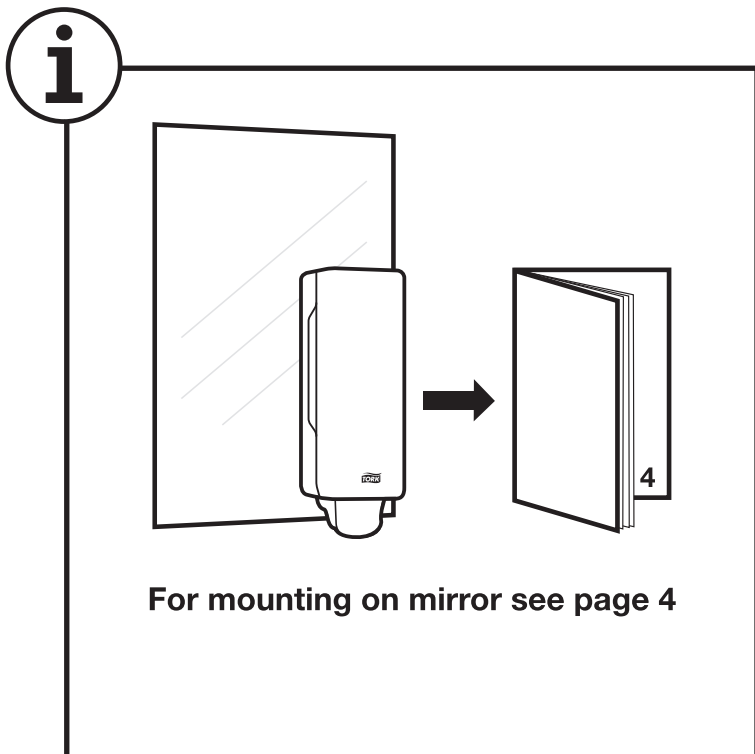
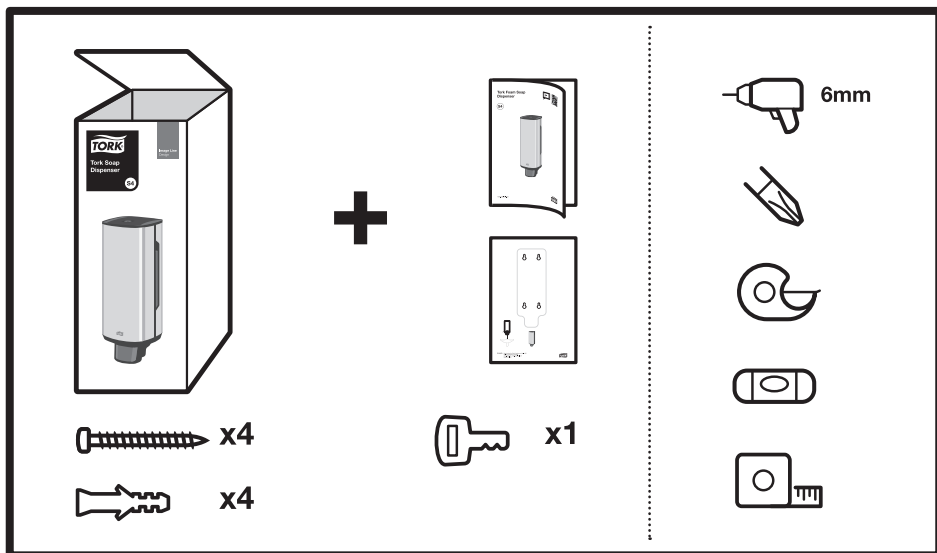

1

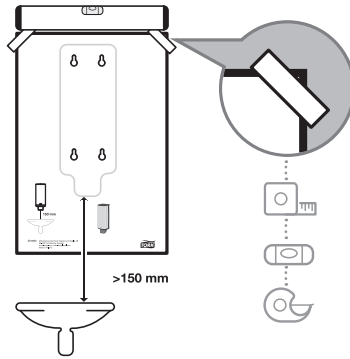

2

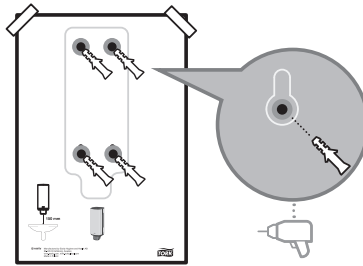

3

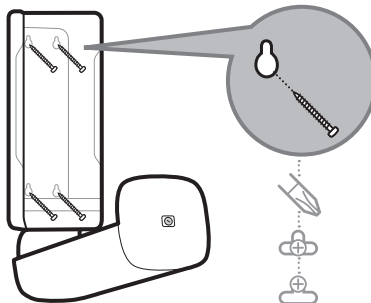

# Tork Foam Soap Dispenser

4

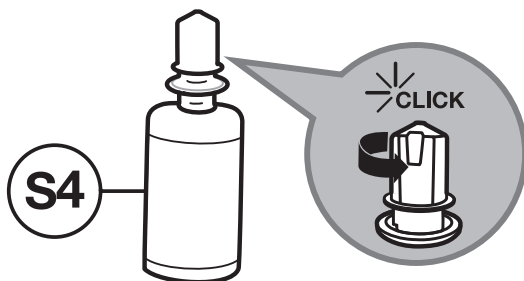

5

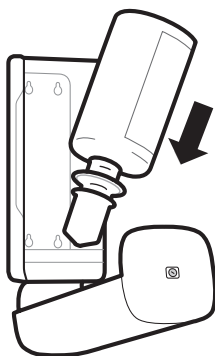

6

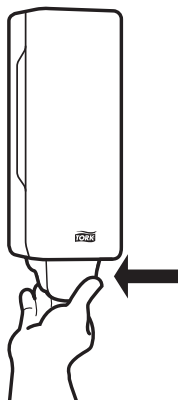

3

**i**

## Mounting on mirror

**1**

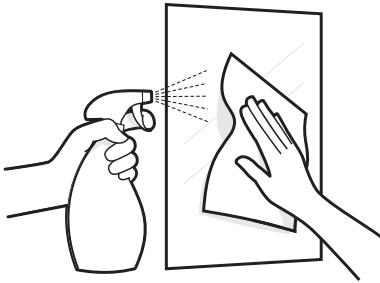

Ensure the mounting surface is flat, clean and dry.

**2**

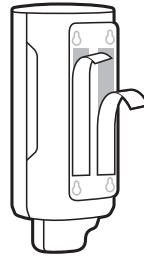

Peel the protective liners from the tape exposing the adhesive.

**3**

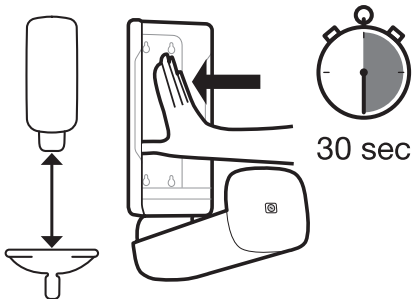

**>150 mm**

Mount the dispenser to the flat surface, press firmly and hold in place for at least 30 seconds.

**4**

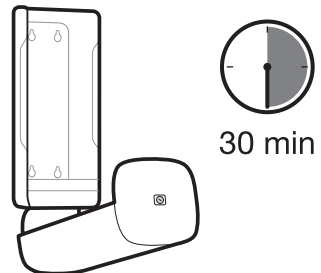

Do not place the refill or batteries in the dispenser for at least 30 minutes.

# Tork Foam Soap Dispenser

4

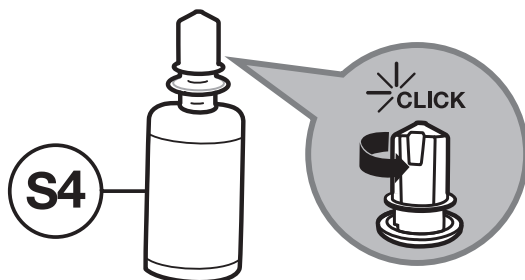

5

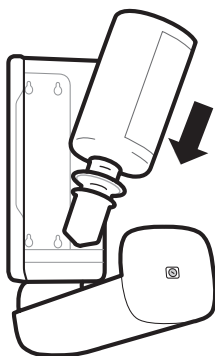

6

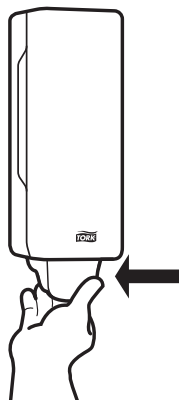

5

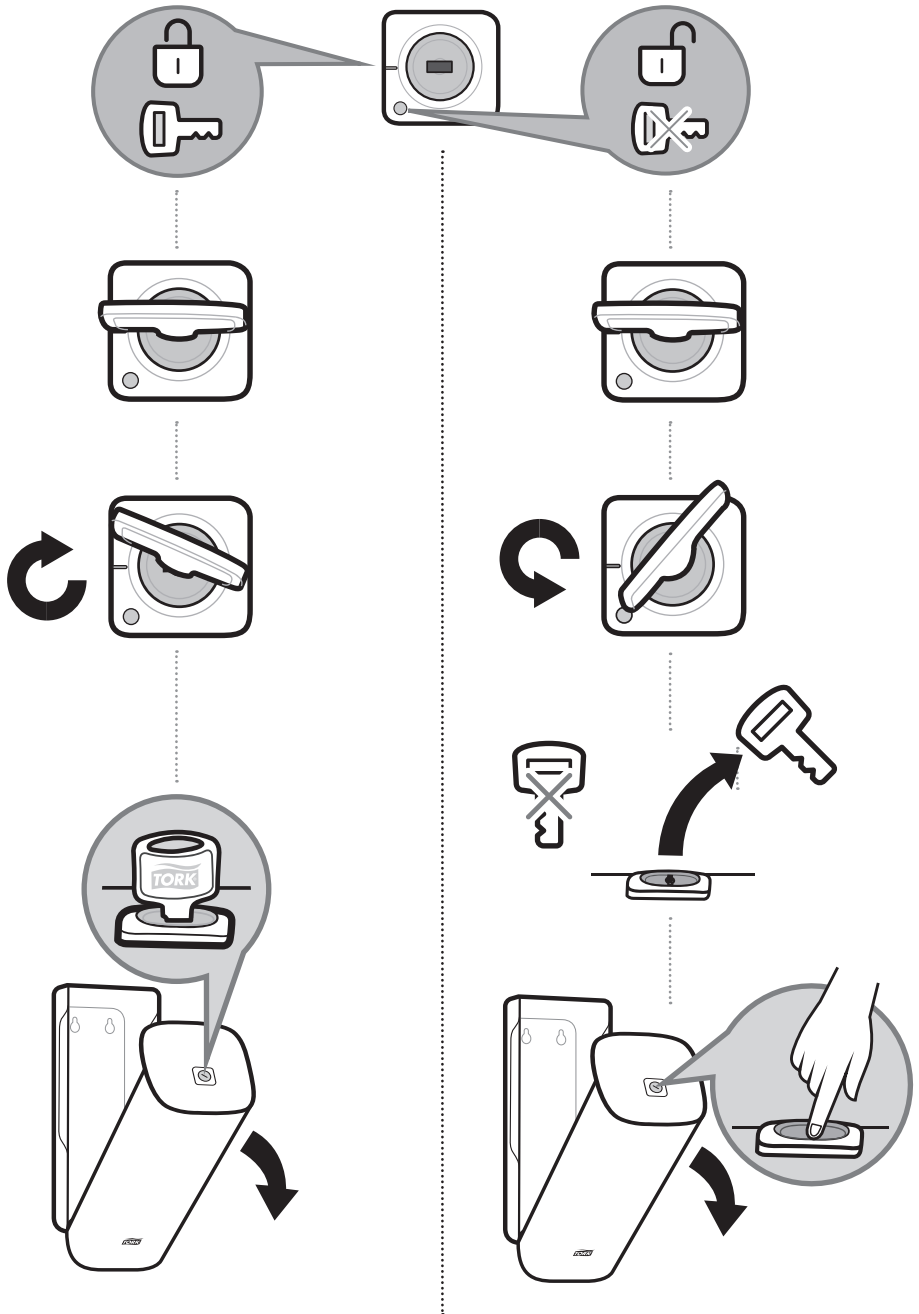

## Disposal

- **Damaged or malfunctioning product should be disposed of immediately to avoid potential of injury**
- **Products should be disposed of in accordance with applicable regulations**

## Cleaning instructions

- **Clean dispenser with mild detergent and soft cloth**

European Community Design Registration RCD 002601922



**essity**

Manufactured by Essity Hygiene and Health AB  
SE-40503 Göteborg, Sweden  
[www.essity.com](http://www.essity.com), [www.torkglobal.com](http://www.torkglobal.com)  
Made in Poland